

2.8

Valve Terminals with 15 pin Sub-D connector

General Information on Valve Terminals

Valve terminal for valves 24 V= and 24 V~.
 All valves with 1.8 Watt/3 VA power consumption.
 2 - 14 stations available, equipped with varistor and red LED. Common Minus or Plus on white cable.

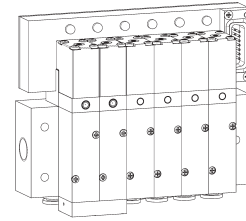
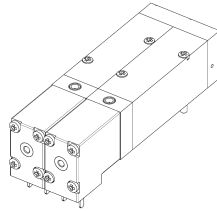

Double solenoid valves (5/2-way and 5/3-way) occupy 2 spaces.

The system is highly water resistant. D-sub-multipin connector and individual valve positions are sealed with NBR O-rings against water and humidity offering IP 65.

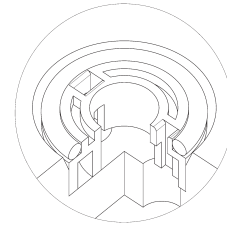
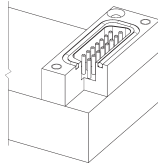

Seal at connector

Seal at valve

Position of the connector can be chosen at the right or at the left hand side of the terminal.

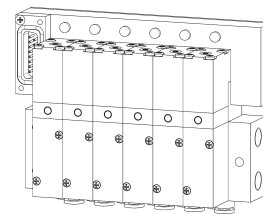
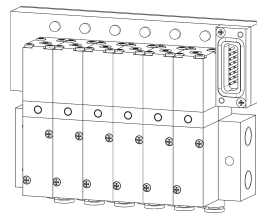

Connector right = TR16

Connector left = TL16

Cable can be supplied with an elbow or a straight electrical connector. Standard cable length is 3 m others are available on request. For details please refer to page 2.8.4.

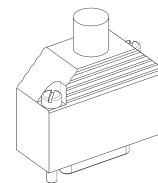
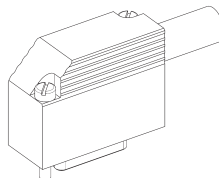

ST40 W__

ST40 G__

General order information:

When ordering a HAFNER valve terminal please proceed as follows:

The electrical and pneumatical manifold has the type-number:

For ordering the required valves add a T to the order code, e.g. MD 510 404 T.

The cable with the connector as displayed on page 2.8.4.

All items to be ordered separately but assembled by manufacturer.

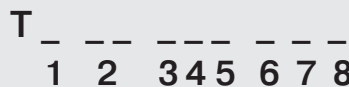

1
 R or L: Defining the side of the connector
 R = right, L = left

2
 16 for valves 16 mm wide
 22 for valves 22 mm wide

3
 3 or 5: Defining if the plate is for 3- or 5-way valves

4, 5
 number of positions, 02 to 14

6, 7, 8
 defining size and position of the ports, please refer to page 2.7.1.2 to 2.7.2.9

T_163__403



Valve terminal with 3-way valves, orifice size 4 mm, port 2 is in the valve. Port 2 is either equipped with thread G 1/8" or with push-in fitting for 6 mm tube.

The terminal is available from 2 to 14 stations (4 to 12 preferred stock item). Every station is equipped with a varistor and a red LED for coils 24 V=.

The pneumatic manifold is displayed and described on page 2.7.1.2, type RD 3__403.

Valves for terminal use offer a 1.8 Watt solenoid, turned by 180° and no 3rd pin (ground). For ordering please add a T to the regular type-number e.g. MD 310 463 T 24DC.

Blanking plates are also available type BP 3 403 T.

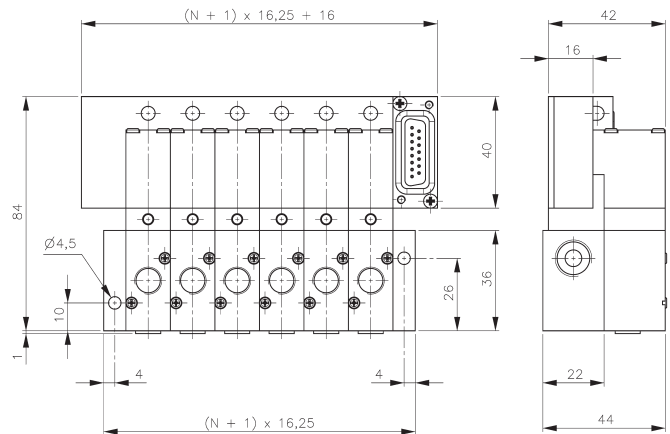

T_163__403
equipped with valves type 403 T

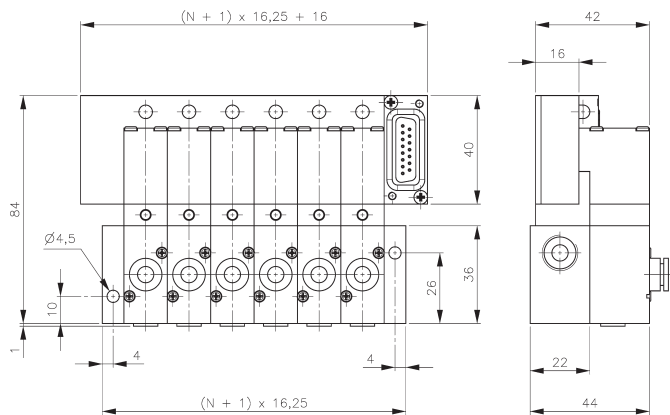

T_163__403
equipped with valves type 463 T

The following valves can be used on that type of valve-terminal:

Type	Function	Page	Comment
MD 310 403 T	n.c.	2.5.1.2.4	all four types of valves can be mixed on one plate
MD 310 463 T	n.c.	2.5.1.2.4	all four types of valves can be mixed on one plate
MOD 310 403 T	n.o.	2.5.1.2.4	all four types of valves can be mixed on one plate
MOD 310 463 T	n.o.	2.5.1.2.4	all four types of valves can be mixed on one plate

For additional order information please refer to page 2.8.1.

T_163__464



Valve terminal with 3-way valves, all ports are in the plate. Type 464 orifice size 4 mm, port 2 is equipped with push-in fitting for 6 mm tube.

The terminal is available from 2 to 14 stations (4 to 12 preferred stock item). Every station is equipped with a varistor and a red LED for coils 24 V=.

The pneumatic manifolds are displayed and described on page 2.7.1.2, type RD 3__464.

Valves for terminal use offer a 1.8 Watt solenoid, turned by 180° and no 3rd pin (ground). For ordering please add a T to the regular type-number e.g. MD 310 404 T 24DC.

Blanking plates are also available type BP 3 404 T.

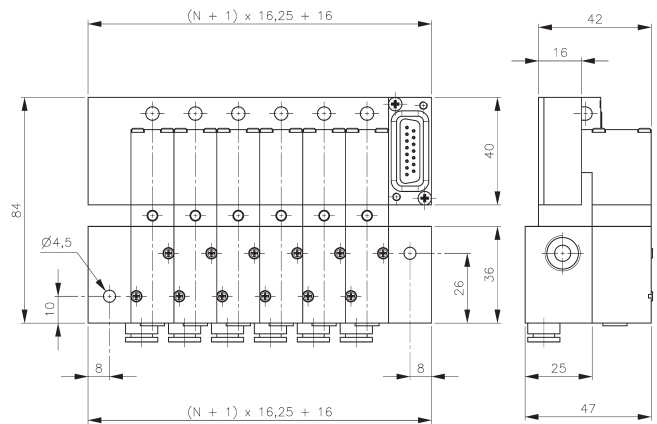

T_163__464
equipped with valves type 404 T

The following valves can be used on T_163__464 n.c. and n.o. can be mixed.

Type	Function	Page
MD 310 404 T	n.c.	2.5.1.2.4
MOD 310 404 T	n.o.	2.5.1.2.4

For additional order information please refer to page 2.8.1.

T_16 5__403



Valve terminal with 5-way valves, orifice size 4 mm, ports 2 and 4 are in the valve. Ports 2 and 4 are either equipped with thread G 1/8" or with push-in fittings for 6 mm tube.

The terminal is available from 2 to 14 stations (4 to 12 preferred stock item). Every station is equipped with a varistor and a red LED for coils 24 V=.

The pneumatic manifold is displayed and described on page 2.7.2.1, type RD 5__403.

Valves for terminal use offer a 1.8 Watt solenoid, turned by 180° and no 3rd pin (ground). For ordering please add a T to the regular type-number e.g. MD 510 403 T 24DC.

"Double body valves" (5/2-way impulse and 5/3-way-valves) occupy 2 spaces as described on page 2.8. 1.

Blanking plates are also available type BP 5 403 T.

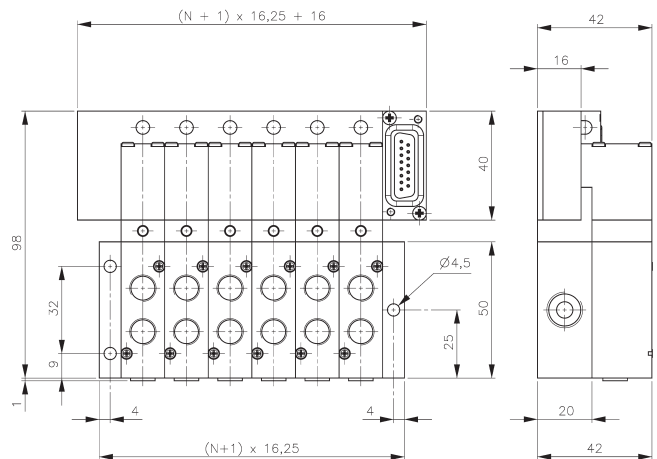

T_16 5__403
equipped with valves type 403 T

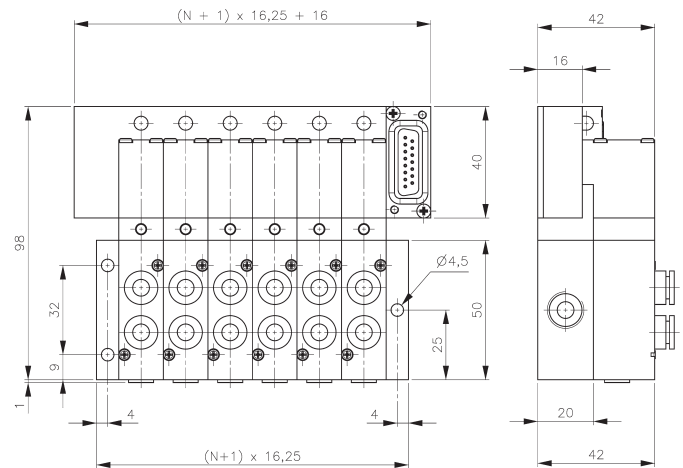

T_16 5__403
equipped with valves type 463 T

The following valves can be used on that type of valve terminal:

Type	Function	Page	Comment
MD 510 403 T	single sol.	2.5.2.2.1	
MD 510 463 T	single sol.	2.5.2.2.1	
MD 520 403 T	double sol.	2.5.2.2.5	double body
MD 520 463 T	double sol.	2.5.2.2.5	double body
MD 53_403 T	5/3-way	2.5.3.2.1	double body, 3 versions available, refer to description
MD 53_463 T	5/3-way	2.5.3.2.1	double body, 3 versions available, refer to description

For additional order information please refer to page 2.8.1.

T_22 5__503/T_22 5__703



Valve terminal with 5-way valves, ports 2 and 4 are in the valve.
 Type 503 orifice size 5 mm, G 1/8"
 Type 703 orifice size 7 mm, G 1/4"

The terminal is available with 2, 3, 4, 5, 6, 8, 10, 12 positions, others on request. Every station is equipped with a varistor and a red LED for coils 24 V=.

The pneumatic manifolds are displayed and described on page 2.7.2.2 type RB 5__503, on page 2.7.2.3 type RB 5__703.

Valves for terminal use offer a 1.8 Watt solenoid, turned by 180° and no 3rd pin (ground).
 Order-number valves: MK 5__03 T 24DC.

Blanking plates are also available type BP 5 503 T or type BP 5 703 T.

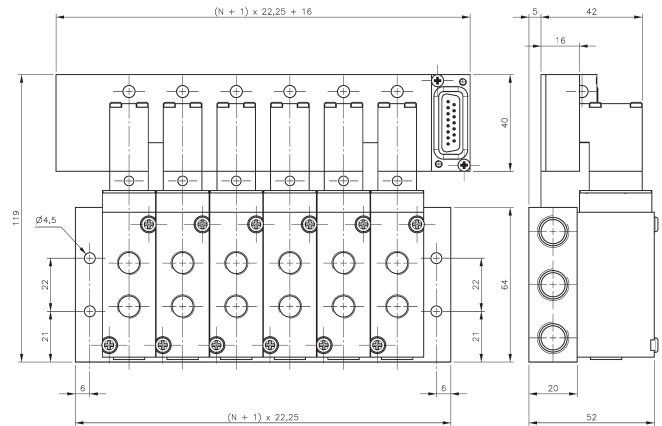

T_22 5__503
 equipped with valves type 503 T

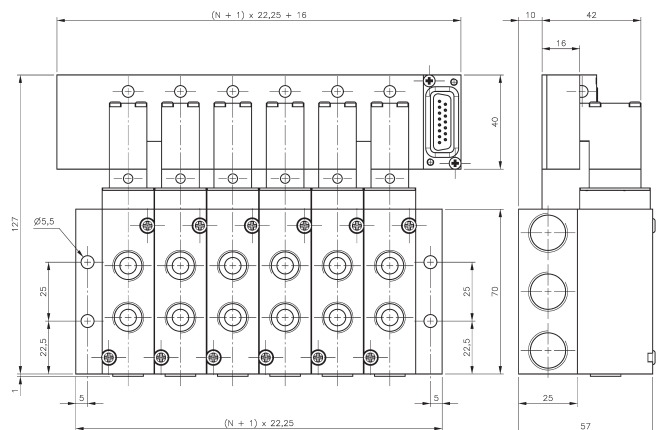

T_22 5__703
 equipped with valves type 703 T

The following valves can be used on T_22 5__503:

Type	Function	Page	Comment
MK 510 503 T	single sol.	2.5.2.2.2	
MK 520 503 T	double sol.	2.5.2.2.6	double body
MK 53__503 T	5/3-way	2.5.3.2.2	double body, 3 versions available, refer to description

The following valves can be used on T_22 5__703:

Type	Function	Page	Comment
MK 510 703 T	single sol.	2.5.2.2.2	
MK 520 703 T	double sol.	2.5.2.2.6	double body
MK 53__703 T	5/3-way	2.5.3.2.2	double body, 3 versions available, refer to description

For additional order information please refer to page 2.8.1.

T_16 5__464



Valve terminal with 5-way valves, orifice size 4 mm, all the ports are in the plate. Ports 2 and 4 are equipped with push-in fittings for 6 mm tube.

The terminal is available from 2 to 14 stations (4 to 12 preferred stock item). Every station is equipped with a varistor and a red LED for coils 24 V=.

The pneumatic manifold is displayed and described on page 2.7.2.6, type RD 5__464.

Valves for terminal use offer a 1.8 Watt solenoid, turned by 180° and no 3rd pin (ground). For ordering please add a T to the regular type-number e.g. MD 510 404 T 24DC. "Double body valves" (5/2-way impulse and 5/3-way-valves) occupy 2 spaces as described on page 2.8.1.

Blanking plates are also available type BP 5 404 T.

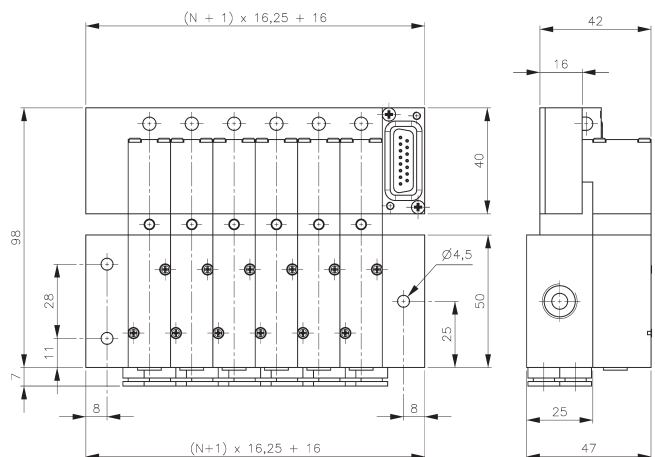

T_16 5__464
equipped with valves type 404 T

The following valves can be used on that type of valve terminal:

Type	Function	Page	Comment
MD 510 404 T	single sol.	2.5.2.2.3	
MD 520 404 T	double sol.	2.5.2.2.3	double body
MD 53__404 T	5/3-way	2.5.2.2.3	double body, 3 versions available, refer to description

For additional order information please refer to page 2.8.1.

T_22 5__504/T_22 5__704

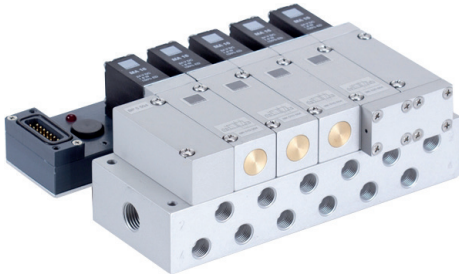

Valve terminal with 5-way valves, all the ports are in the plate.

Type 504 orifice size 5 mm, G 1/8"
Type 704 orifice size 7 mm, G 1/4"

The terminal is available with 2, 3, 4, 5, 6, 8, 10, 12 positions, others on request. Every station is equipped with a varistor and a red LED for coils 24 V=.

The pneumatic manifolds are displayed and described on page 2.7.2.7, type RB 5__504, on page 2.7.2.8 type RB 5__704.

Valves for terminal use offer a 1.8 Watt solenoid, turned by 180° and no 3rd pin (ground).

Order-number valves: MK 5__04 T 24DC.
Blanking plates are also available type BP 5 504 T or type BP 5 704 T.

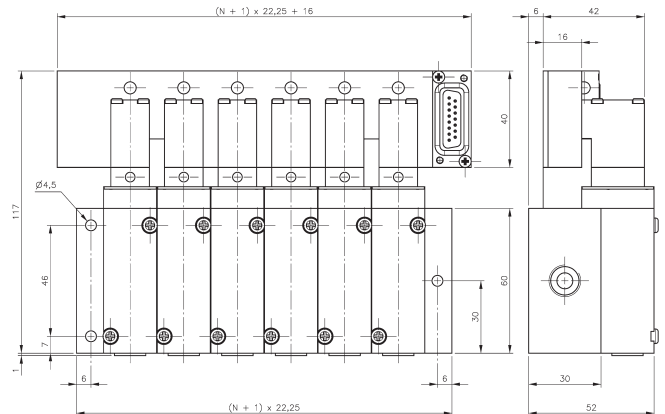

T_22 5__504
equipped with valves type 504 T

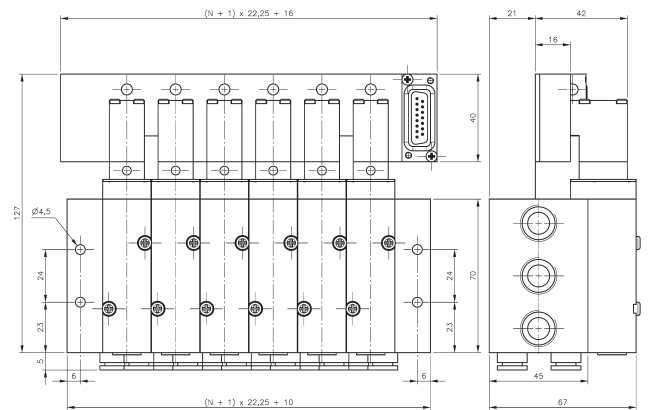

T_22 5__784
equipped with valves type 704 T

The following valves can be used on T_22 5__504:

Type	Function	Page	Comment
MK 510 504 T	single sol.	2.5.2.2.4	
MK 520 504 T	double sol.	2.5.2.2.7	double body
MK 53_504 T	5/3-way	2.5.3.2.3	double body, 3 versions available, refer to description

The following valves can be used on T_22 5__704:

Type	Function	Page	Comment
MK 510 704 T	single sol.	2.5.2.2.4	
MK 520 704 T	double sol.	2.5.2.2.7	double body
MK 53_704 T	5/3-way	2.5.3.2.3	double body, 3 versions available, refer to description

For additional order information please refer to page 2.8.1.

T_22 5__704 K1



Valve terminal with 5-way valves, orifice 7 mm, all the ports are in the plate.
Plates are designed for assemblage in control cabinets.

Ports 2 and 4: G 1/4".

The terminal is available with 2, 3, 4, 5, 6, 8, 10, 12 positions, others on request. Every station is equipped with a varistor and red LED for coils 24V=.

The pneumatic manifolds are displayed and described on page 2.7.2.9, type RB 5__704 K1.

Valves for terminal use offer a 1.8 Watt solenoid, turned by 180° and no 3rd pin (ground).
Order-number valves: MK 5__704T 24DC.

3/2-way functions by closing either port 2 or 4.

Blanking plates are also available type BP 5 704.

In case the customer wants to have the FRL inside the box, the endplate left offers as second supply port that faces inside the box. One of the two has to be closed with a G 3/8" plug.

The valve terminals are also available with individual valve isolation. In certain industries the user appreciates, if he can take away air pressure at any valve on the plate individually. Valves can easily be exchanged by closing the plug in port 1 without interruption of the air-supply of the other valves. If requested, please order T_5__704 K1D1.

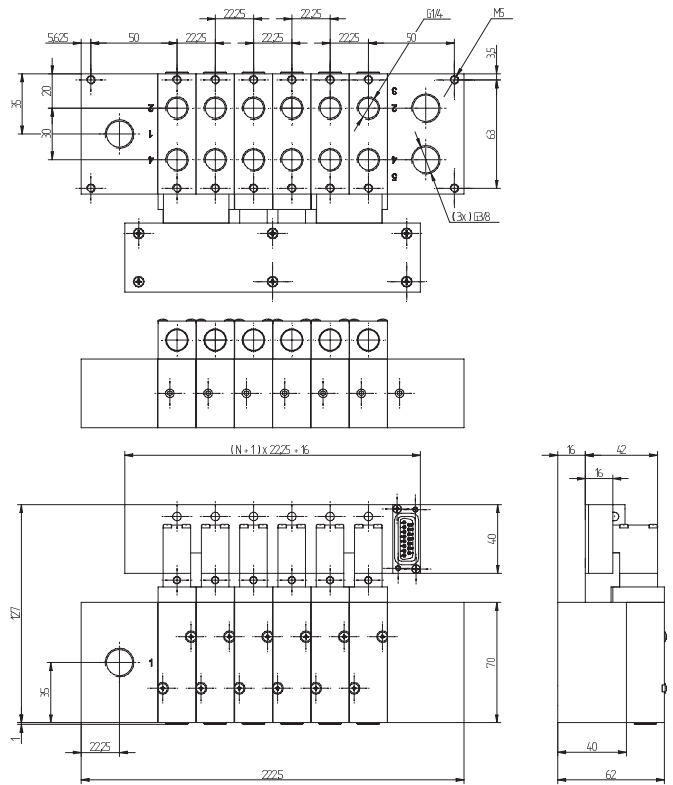

T_22 5__704 K1
equipped with valves type 704 T

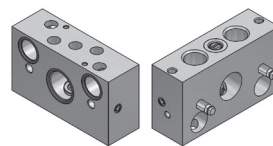

Individual valve isolation

The following valves can be used on that type of valve terminal:

Type	Function	Page	Comment
MK 510 704 T	single sol.	2.5.2.2.4	
MK 520 704 T	double sol.	2.5.2.2.7	double body
MK 53__704 T	5/3-way	2.5.3.2.3	double body, 3 versions available, refer to description

For additional order information please refer to page 2.8.1.

Connectors and Cable ST40 W__

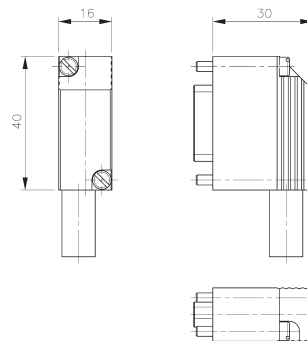

ST40 W__

Connector and cables for HAFNER valve-terminals.
O-ring seal assures best protection against water and humidity.
Standard cable length is 3 m, others are available on request.

2 screws are included.

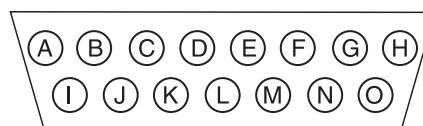

Relationship of valve-position, cable-colour and PINS in the connector

Position of solenoid	Colour of cable	PIN
1	brown	K
2	green	M
3	yellow	C
4	grey	F
5	pink	J
6	blue	N
7	red	B
8	black	G
9	violet	I
10	grey-pink	O
11	blue-red	A
12	white-green	H
13	brown-green	D
14	white-yellow	E
common – or +	white	L

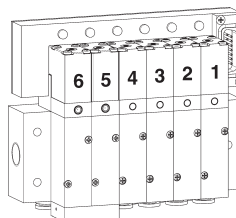

Please be aware: Always count position of solenoid from the connector !

Type	Exit of cable	Number of laces
ST40 W06	at the side	7, 6 positions and common Plus or Minus
ST40 W14	at the side	15, 14 positions and common Plus or Minus

