

2.3

Lever Actuated Valves

Selected valves can be used for technical vacuum too.

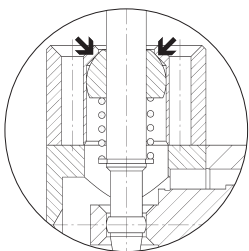

Instead of a rubber-gaitor that never lasts long, HAFNER seals all the lever valves with a metallic seal.



Selected models are available for low temperature application. For detailed information refer to chapter 2.12.



316 Selected models are available in stainless steel. For detailed information refer to chapter 2.13.



Selected models can be equipped with FKM seals for high temperature environment up to 120 °C.

Selected models can be used in explosion hazardous environment. For detailed information refer to chapter 2.15.

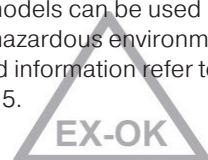

HV 311 501/HV 311 701/HV 311 801 HVR 320 501/HVR 320 701/HVR 320 801

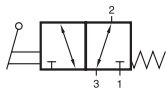

HV 311 501
HV 311 701
HV 311 801
HV 311 701 NPT

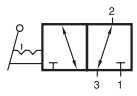

HVR 320 501
HVR 320 701
HVR 320 801
HVR 320 701 NPT

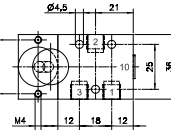
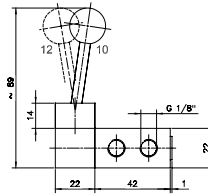

HV 311 501/HVR 320 501

Lever actuated 3/2-way spool valve.

Type HV spring return
Type HVR indexed

If pressure is applied to port 1 the function is normally closed.
If pressure is applied to port 3 the function is normally open.

The lever is sealed by using a metal ball.

Exhaust can be throttled.

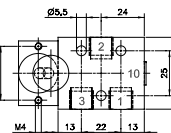
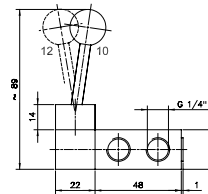

**HV 311 701/HVR 320 701
HV 311 701 NPT/HVR 320 701 NPT**

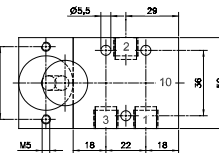
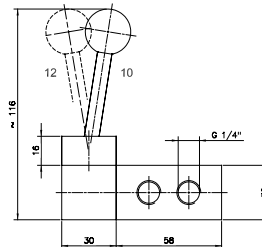

HV 311 801/HVR 320 801

Type	Function	Port size	Air flow	Operating press.	Actuating force	Weight
HV 311 501	spring ret.	G 1/8"	650 l/min	1 - 10 bar	20 N	0,19 kg
HV 311 701	spring ret.	G 1/4"	1250 l/min	1 - 10 bar	20 N	0,20 kg
HV 311 801	spring ret.	G 1/4"	1450 l/min	1 - 10 bar	25 N	0,46 kg
HVR 320 501	indexed	G 1/8"	650 l/min	1 - 10 bar	20 N	0,19 kg
HVR 320 701	indexed	G 1/4"	1250 l/min	1 - 10 bar	20 N	0,20 kg
HVR 320 801	indexed	G 1/4"	1450 l/min	1 - 10 bar	25 N	0,46 kg
HV 311 701 NPT	spring ret.	1/4" NPT	1250 l/min	1 - 10 bar	20 N	0,20 kg
HVR 320 701 NPT	indexed	1/4" NPT	1250 l/min	1 - 10 bar	20 N	0,20 kg

HV 311 101/HV 311 121/HV 311 181 HVR 320 101/HVR 320 121/HVR 320 181

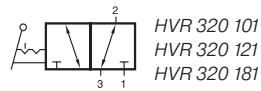
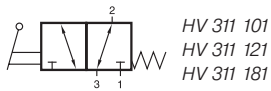

Lever actuated 3/2-way spool valve.

Type HV spring return
Type HVR indexed

If pressure is applied to port 1 the function is normally closed.
If pressure is applied to port 3 the function is normally open.

The lever is sealed by using a metal ball.

Exhaust can be throttled.

Versions with 1/2" NPT ports available on request.

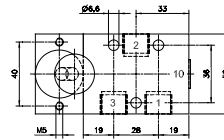
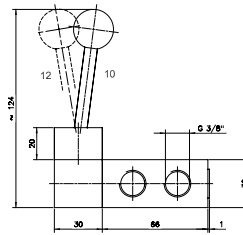

HV 311 101/HVR 320 101

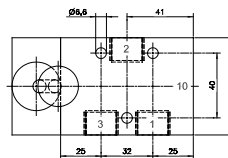
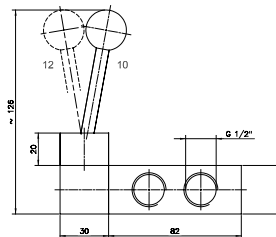

HV 311 121/HVR 320 121

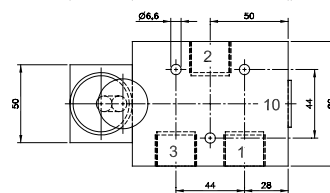
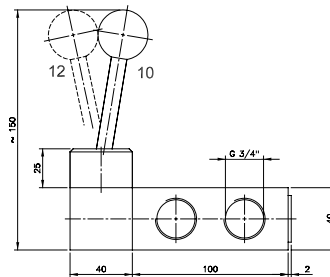

HV 311 181/HVR 320 181

Type	Function	Port size	Air flow	Operating press.	Actuating force	Weight
HV 311 101	spring ret.	G 3/8"	2250 l/min	1 - 10 bar	25 N	0,49 kg
HV 311 121	spring ret.	G 1/2"	3000 l/min	1 - 10 bar	32 N	0,69 kg
HV 311 181	spring ret.	G 3/4"	6000 l/min	1 - 10 bar	40 N	1,31 kg
HVR 320 101	indexed	G 3/8"	2250 l/min	1 - 10 bar	25 N	0,49 kg
HVR 320 121	indexed	G 1/2"	3000 l/min	1 - 10 bar	32 N	0,69 kg
HVR 320 181	indexed	G 3/4"	6000 l/min	1 - 10 bar	40 N	1,31 kg

HV 511 501/HV 511 701/HV 511 801 HVR 520 501/HVR 520 701/HVR 520 701 L HVR 520 801

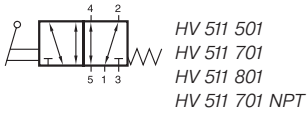

HV 511 501
HV 511 701
HV 511 801
HV 511 701 NPT

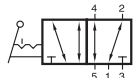

HVR 520 501
HVR 520 701
HVR 520 801
HVR 520 701 NPT

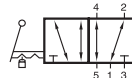

HVR 520 701 L

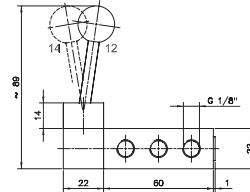

HV 511 501/HVR 520 501

Lever actuated 5/2-way spool valve.

Type HV spring return
Type HVR indexed

The lever is sealed by using a metal ball.

Exhaust can be throttled.

Type HVR 520 701 L with extended spool.

The user can put a padlock into the drilling and thereby lock the valve. Padlock is not included in the delivery content.

Valve is also designed to resist high temperatures of up to +120°C.

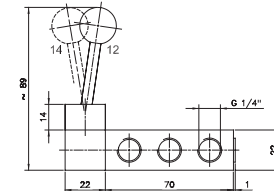
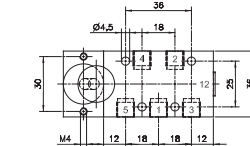

**HV 511 701/HVR 520 701
HV 511 701 NPT/HVR 520 701 NPT**

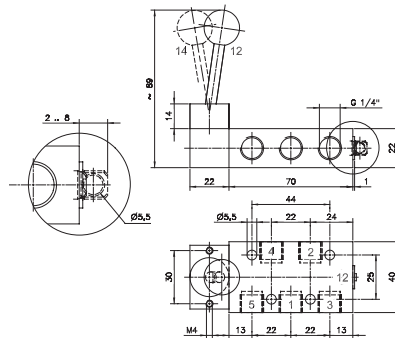
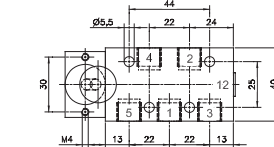

HVR 520 701 L

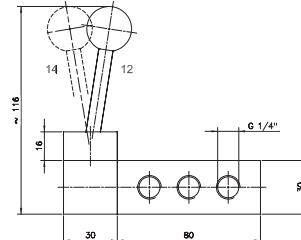

HV 511 801/HVR 520 801

Type	Function	Port size	Air flow	Operating press.	Actuating force	Weight
HV 511 501	spring ret.	G 1/8"	650 l/min	1 - 10 bar	20 N	0,22 kg
HV 511 701	spring ret.	G 1/4"	1250 l/min	1 - 10 bar	20 N	0,24 kg
HV 511 801	spring ret.	G 1/4"	1450 l/min	1 - 10 bar	25 N	0,55 kg
HVR 520 501	indexed	G 1/8"	650 l/min	1 - 10 bar	20 N	0,22 kg
HVR 520 701	indexed	G 1/4"	1250 l/min	1 - 10 bar	20 N	0,24 kg
HVR 520 701 L	indexed	G 1/4"	1250 l/min	1 - 10 bar	20 N	0,24 kg
HVR 520 801	indexed	G 1/4"	1450 l/min	1 - 10 bar	25 N	0,55 kg
HV 511 701 NPT	spring ret.	1/4" NPT	1250 l/min	1 - 10 bar	20 N	0,24 kg
HVR 520 701 NPT	indexed	1/4" NPT	1250 l/min	1 - 10 bar	20 N	0,24 kg

HV 511 101/HV 511 121/HV 511 181 HVR 520 101/HVR 520 121/HVR 520 181

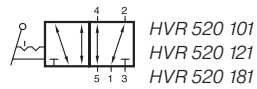
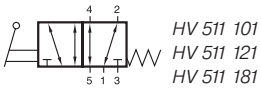

Lever actuated 5/2-way spool valve.

Type HV spring return
Type HVR indexed

The lever is sealed by using a metal ball.

Exhaust can be throttled.

Versions with 1/2" NPT ports available on request.

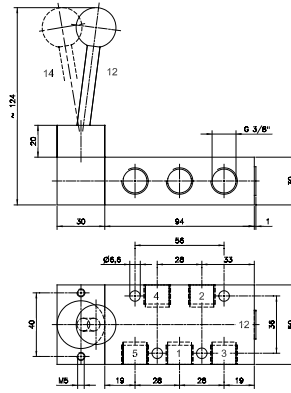

HV 511 101/HVR 520 101

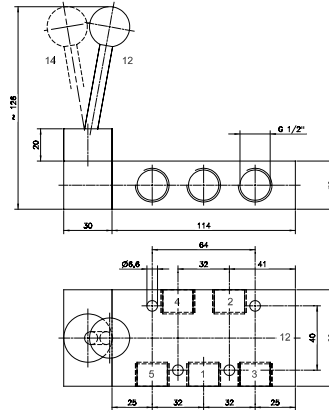

HV 511 121/HVR 520 121

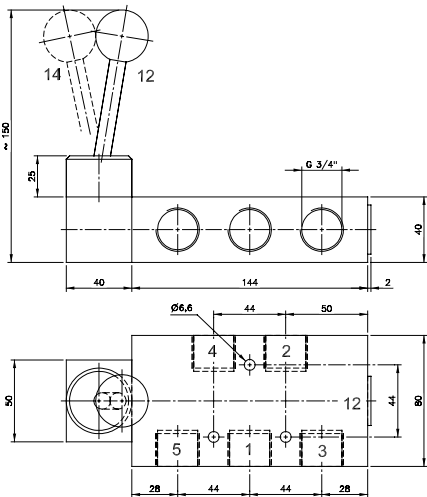

HV 511 181/HVR 520 181

Type	Function	Port size	Air flow	Operating press.	Actuating force	Weight
HV 511 101	spring ret.	G 3/8"	2250 l/min	1 - 10 bar	25 N	0,60 kg
HV 511 121	spring ret.	G 1/2"	3000 l/min	1 - 10 bar	32 N	0,79 kg
HV 511 181	spring ret.	G 3/4"	6000 l/min	1 - 10 bar	40 N	1,64 kg
HVR 520 101	indexed	G 3/8"	2250 l/min	1 - 10 bar	25 N	0,60 kg
HVR 520 121	indexed	G 1/2"	3000 l/min	1 - 10 bar	32 N	0,79 kg
HVR 520 181	indexed	G 3/4"	6000 l/min	1 - 10 bar	40 N	1,64 kg

HV 53_ 501/HV 53_ 701/HV 53_ 801 HVR 53_ 501/HVR 53_ 701/ HVR 53_ 801

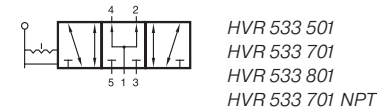
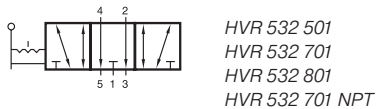
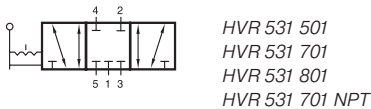
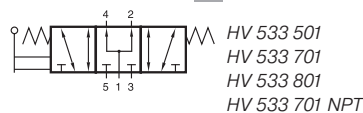
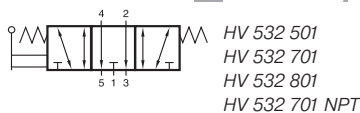
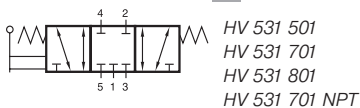

Lever actuated 5/3-way spool valve.

Type HV spring return to middle position

Type HVR indexed

Type 531 centre closed

Type 532 centre exhausted

Type 533 centre pressurised

When ordering please complete the type number by 1, 2 or 3 according to the type required.

The lever is sealed by using a metal ball.

Exhaust can be throttled.

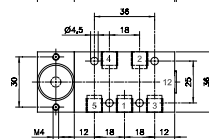
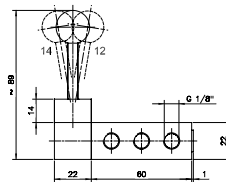

HV 53_ 501/HVR 53_ 501

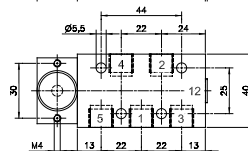
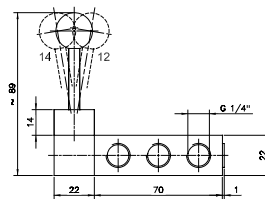

**HV 53_ 701/HVR 53_ 701
HV 53_ 701 NPT/HVR 53_ 701 NPT**

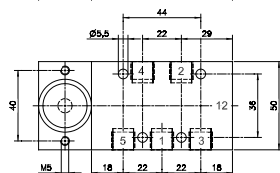
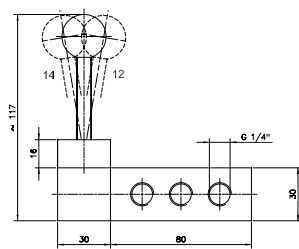

HV 53_ 801/HVR 53_ 801

Type	Function	Port size	Air flow	Operating press.	Actuating force	Weight
HV 53_ 501	spring ret.	G 1/8"	650 l/min	1 - 10 bar	20 N	0,22 kg
HV 53_ 701	spring ret.	G 1/4"	1250 l/min	1 - 10 bar	20 N	0,24 kg
HV 53_ 801	spring ret.	G 1/4"	1450 l/min	1 - 10 bar	25 N	0,55 kg
HVR 53_ 501	indexed	G 1/8"	650 l/min	1 - 10 bar	20 N	0,22 kg
HVR 53_ 701	indexed	G 1/4"	1250 l/min	1 - 10 bar	20 N	0,24 kg
HVR 53_ 801	indexed	G 1/4"	1450 l/min	1 - 10 bar	25 N	0,55 kg
HV 53_ 701 NPT	spring ret.	1/4" NPT	1250 l/min	1 - 10 bar	20 N	0,24 kg
HVR 53_ 701 NPT	indexed	1/4" NPT	1250 l/min	1 - 10 bar	20 N	0,24 kg

HV 53_ 101/HV 53_ 121/HV 53_ 181 HVR 53_ 101/HVR 53_ 121/HVR 53_ 181

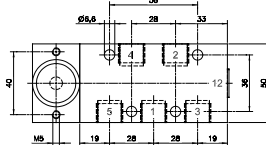
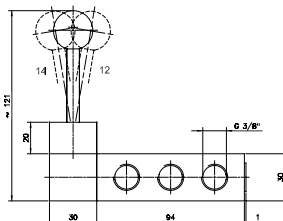
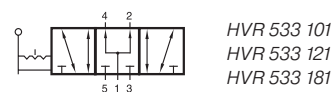
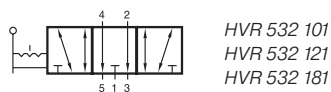
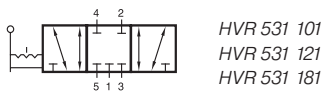
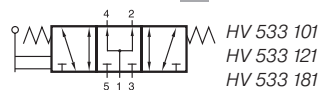
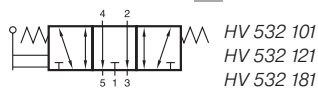
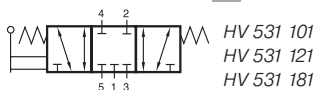

HV 53_ 101/HVR 53_ 101

Lever actuated 5/3-way spool valve with.

Type HV spring return to middle position
Type HVR indexed

Type 531 centre closed
Type 532 centre exhausted
Type 533 centre pressurised

When ordering please complete the type number by 1, 2 or 3 according to the type required.

The lever is sealed by using a metal ball.

Exhaust can be throttled.

Versions with 1/2" NPT ports available on request.

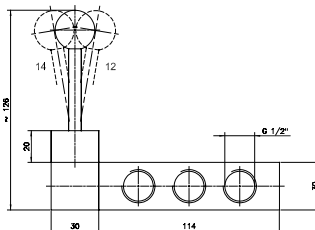

HV 53_ 121/HVR 53_ 121

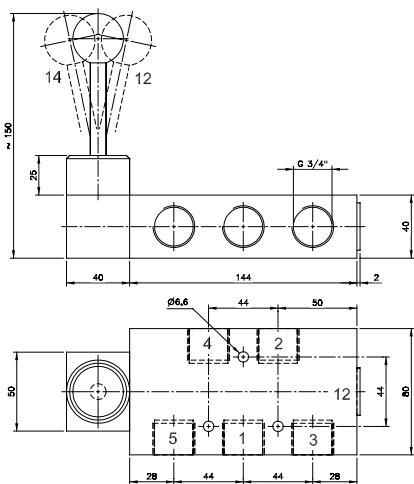

HV 53_ 181/HVR 53_ 181

Type	Function	Port size	Air flow	Operating press.	Actuating force	Weight
HV 53_ 101	spring ret.	G 3/8"	2250 l/min	1 - 10 bar	25 N	0,60 kg
HV 53_ 121	spring ret.	G 1/2"	3000 l/min	1 - 10 bar	32 N	0,80 kg
HV 53_ 181	spring ret.	G 3/4"	6000 l/min	1 - 10 bar	40 N	1,64 kg
HVR 53_ 101	indexed	G 3/8"	2250 l/min	1 - 10 bar	25 N	0,60 kg
HVR 53_ 121	indexed	G 1/2"	3000 l/min	1 - 10 bar	32 N	0,80 kg
HVR 53_ 181	indexed	G 3/4"	6000 l/min	1 - 10 bar	40 N	1,64 kg

HV 511 704/HVR 520 704 HV 53_704/HVR 53_704

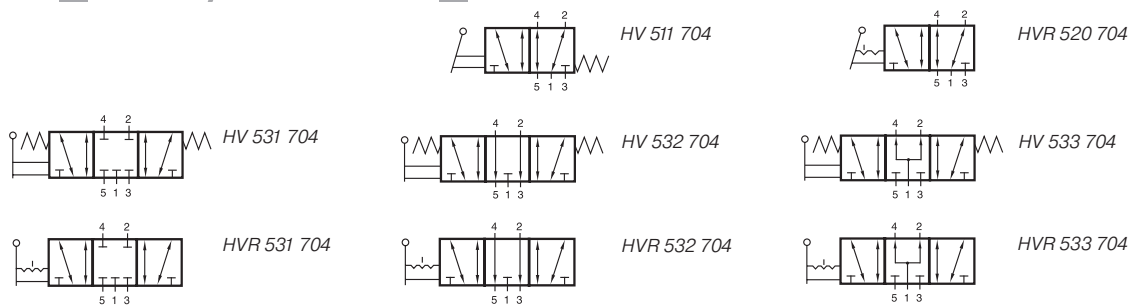

Lever actuated 5/2-way and 5/3-way spool valves. All the ports are in the plate.

Type HV spring return
Type HVR indexed

Type 511 and 520 5/2-way
Type 531 centre closed 5/3-way
Type 532 centre exhausted 5/3-way
Type 533 centre pressurised 5/3-way

The lever is sealed by using a metal ball.

Manifolds are displayed on page 2.7.2.8.

Blanking plates are also available type BP 5 704.

Mounting screws and seals are included.

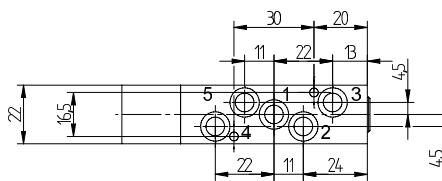

HV 511 704/HVR 520 704

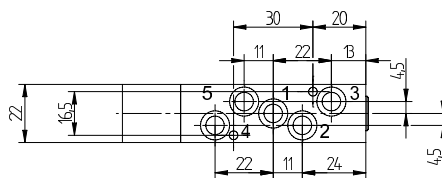

HV 53_704/HVR 53_704

Type	Function	Port size	Air flow	Operating press.	Actuating force	Weight
HV 511 704	5/2-way spring ret.	Ø 7 mm	1250 l/min	1 - 10 bar	20 N	0,20 kg
HVR 520 704	5/2-way indexed	Ø 7 mm	1250 l/min	1 - 10 bar	20 N	0,20 kg
HV 53_704	5/3-way spring ret.	Ø 7 mm	1250 l/min	1 - 10 bar	20 N	0,20 kg
HVR 53_704	5/3-way indexed	Ø 7 mm	1250 l/min	1 - 10 bar	20 N	0,20 kg